

4S fra et teknisk perspektiv

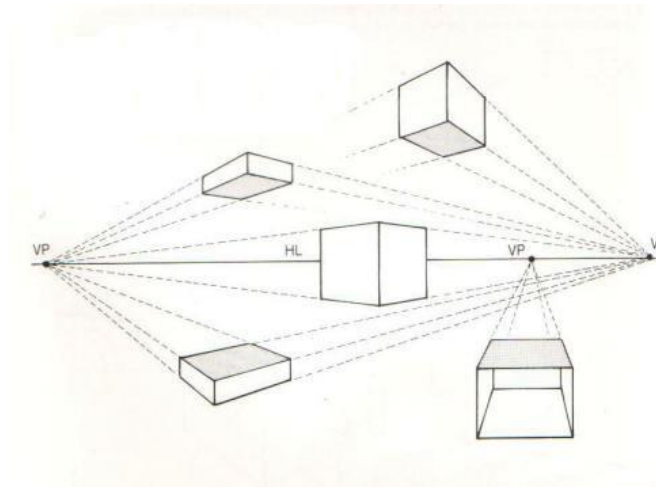

Kontaktinformation

Torben Bisgaard Haagh
Senior Softwarearkitekt
Pervasive Healthcare Lab
Alexandra Instituttet



M: [24802558](tel:24802558)

E: torben.haagh@alexandra.dk

W: <http://www.alexandra.dk/torben.haagh>

L: <http://linkedin.com/in/tbhaagh>



Spørgsmål undervejs

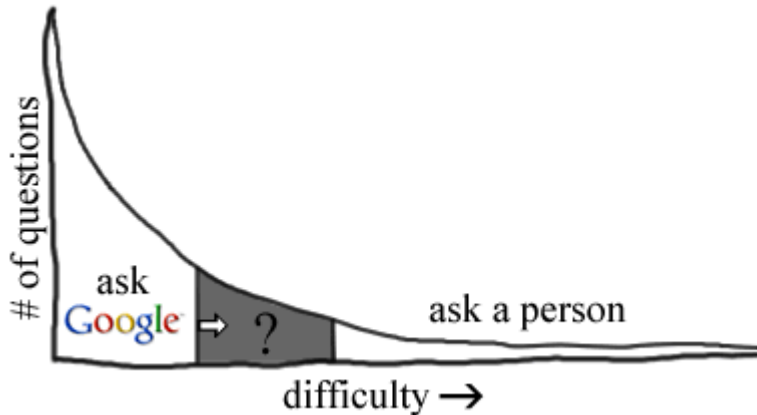
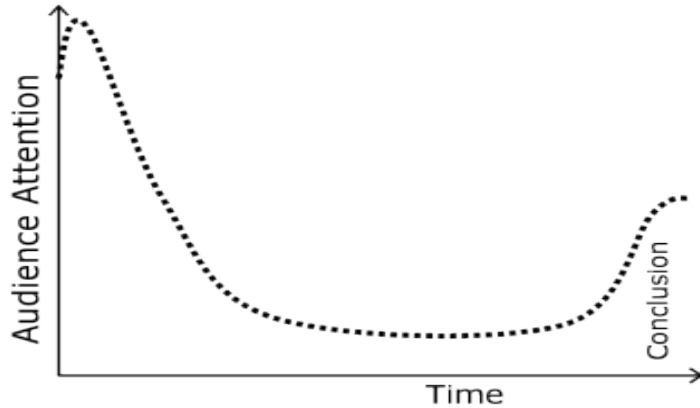

"I'll start with the weekly progress report. Ms. London, on my right, will act as acronym and jargon translator."

Handlingsplan

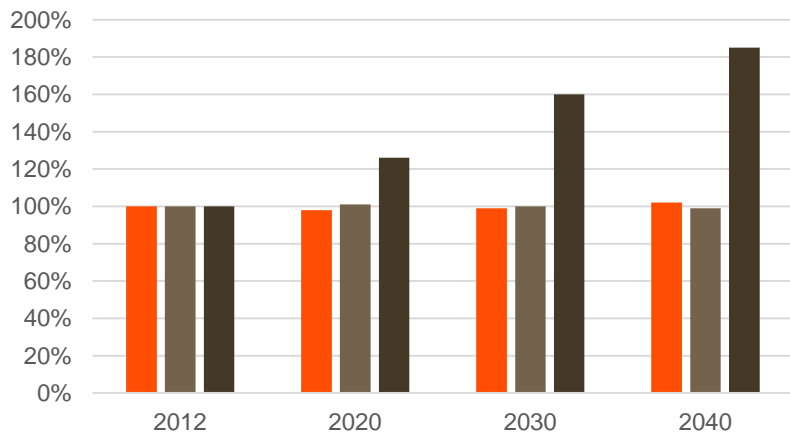
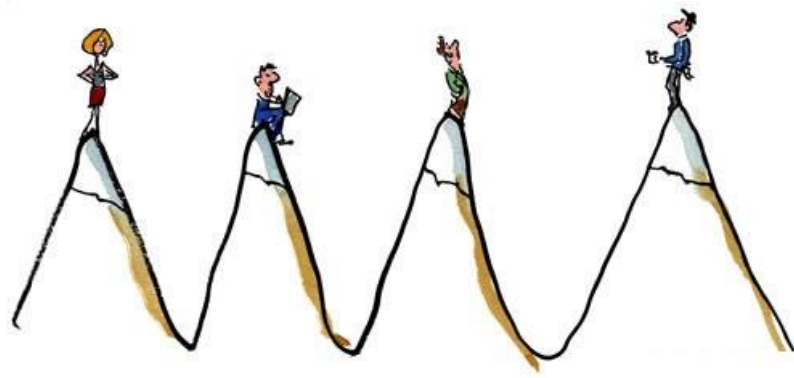

- 0-19
- 20-69
- 70+



Referencearkitekturer

- Referencearkitekturer for
 - deling af dokumenter og billeder
 - opsamling af helbredsdata hos borgeren
 - informationssikkerhed
 - ...
- Udgives af NSI
 - Afgrænser et område
 - Har fælles begrebsforståelse
 - Beskriver forretningsmæssige mål og ønskede egenskaber
 - Fastlægger principper for løsninger
 - Beskriver løsningselementer og processer på et overordnet niveau
 - Identificerer områder der bør være genstand for standardisering
 - Giver evt. bud på hvilke standarder der kan anvendes



Deling af dokumenter og billeder

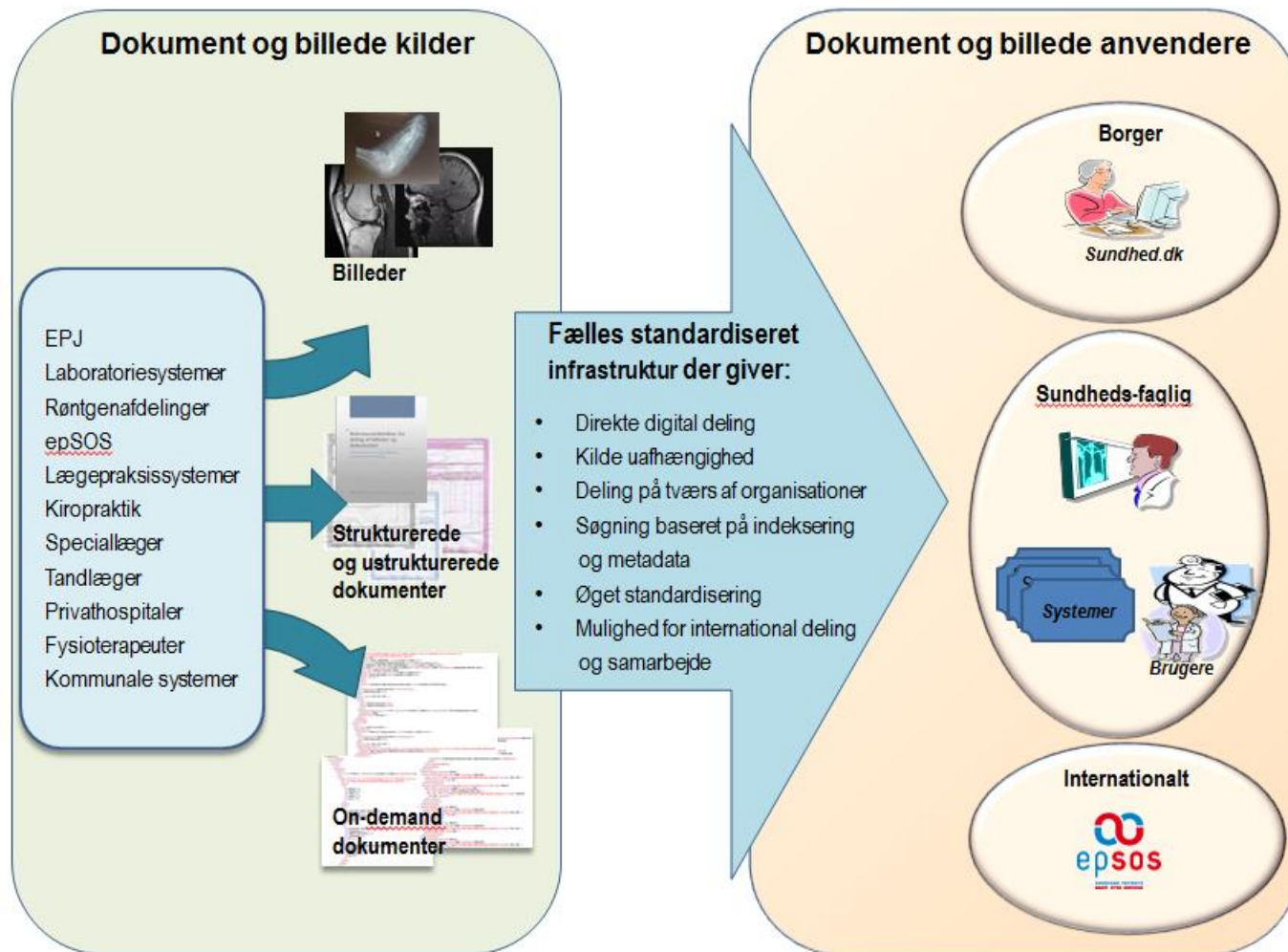

IHE XDS

- XDS: Cross-Enterprise Document Sharing
- Profil fra IHE: Integrating the Healthcare Enterprise
- Specificerer hvordan dokumenter gemmes og deles
- Har et indeks og et antal lagre
- Indekset gemmer søgbart metadata
- Lageret gemmer vilkårligt indhold
- Lageret er ikke søgbart
- Snitfalden er en SOAP-service
- Eksempel et national indeks og et lager i hver region

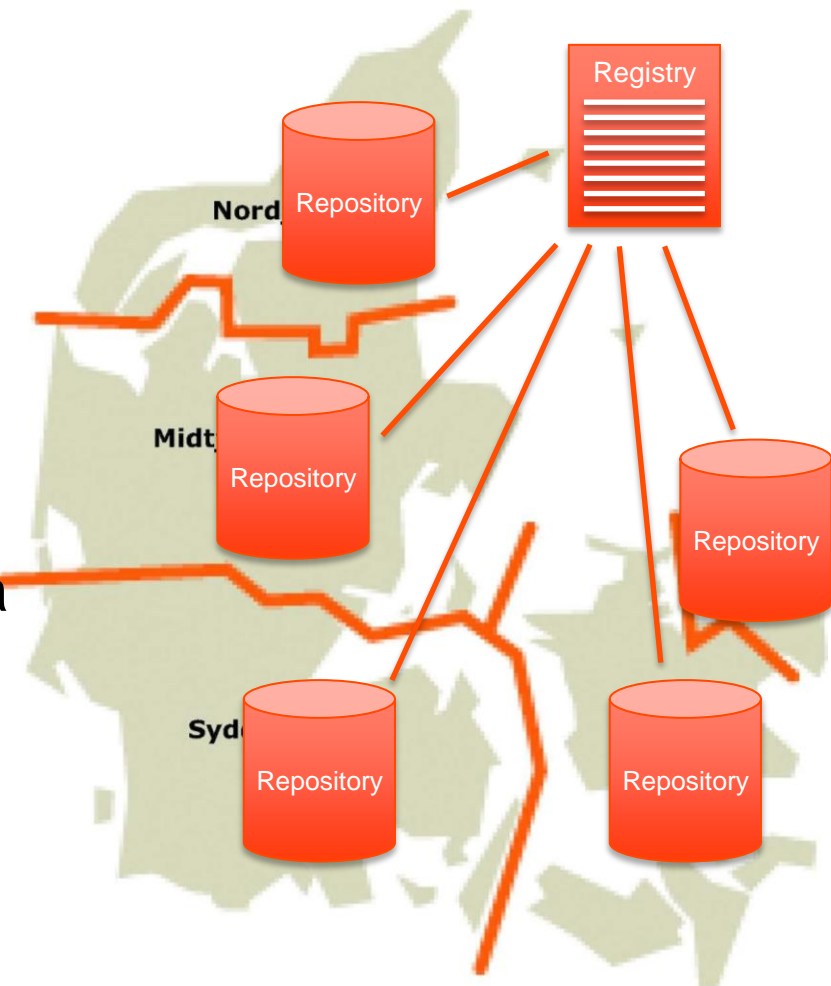

XDS Flow

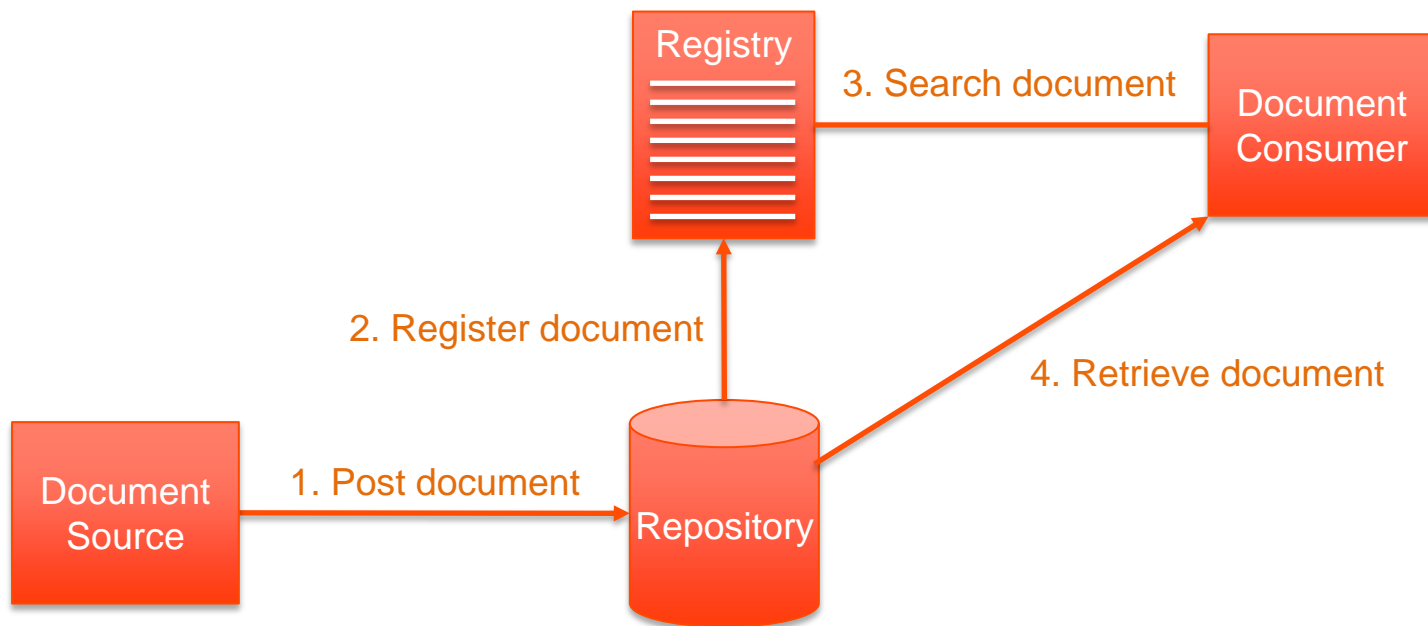

XDS Affinity Domain

- Fælles politik for dokument format, struktur og indhold
 - Samme patient id-håndtering
 - Samme kodesystem
 - Aftaler om sikkerhed, jura, mv.
 - Metadata
- Defineret for et indeks
- Dansk profilering af XDS metadata i gang

IHE XCA

- XCA: Cross Community Access
- Muliggør at indekser kan tale sammen
- Eksempel et et indeks i hver region, som taler sammen med XCA, og så lagre i regioner og potentiel kommuner

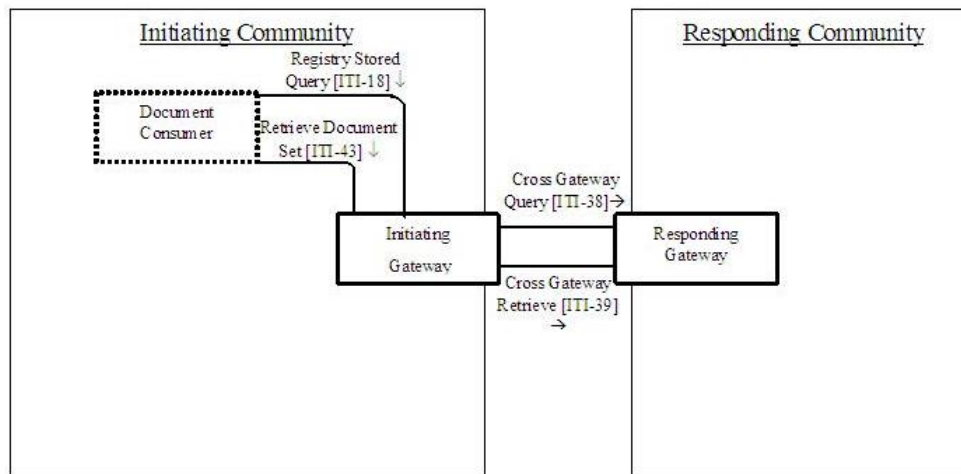

Øvrige standarder i "RfDDB"

- CT: Consistent Time
- ATNA: Audit Trail and Node Authentication
- BPPC: Basic Patient Privacy Consents
- XUA: Cross Enterprise User Assertion
- PWP: Personnel White Pages
- XCPD: Cross-Community Patient Discovery



Opsamling af helbredsdata hos borgeren

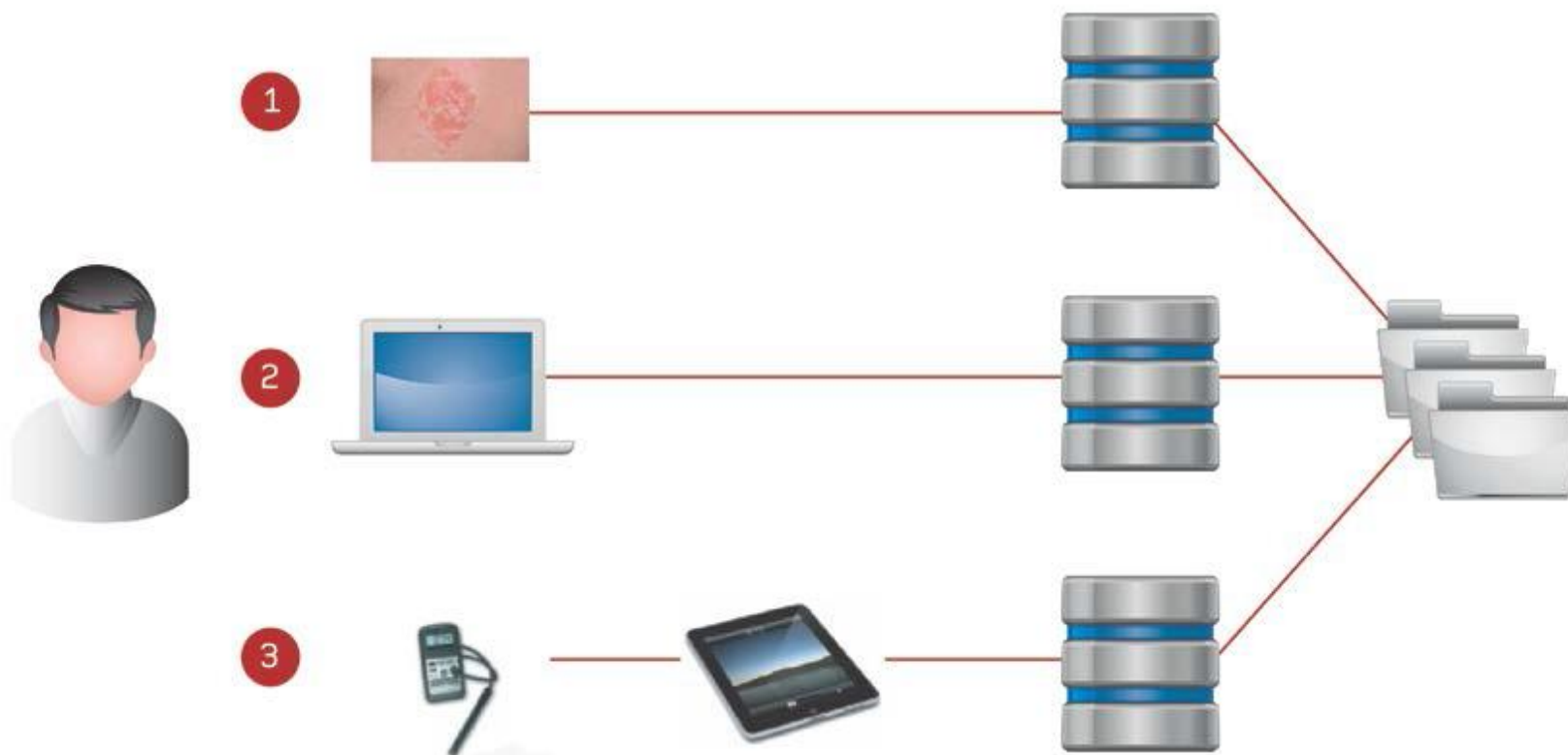

Continua Alliance rammeværk

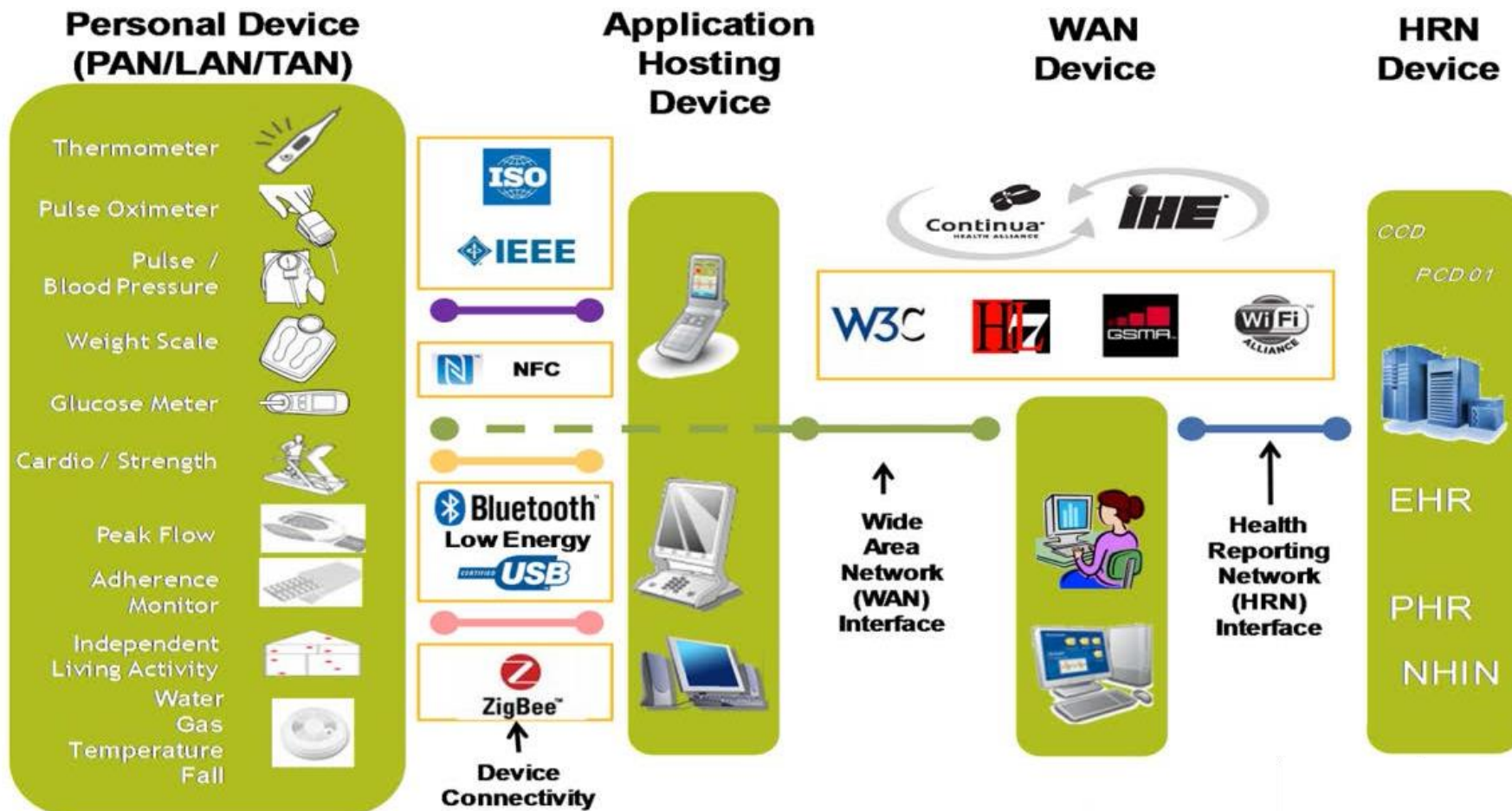

IEEE 11073

PCD-01

XDS/PHMR



HL7 CDA

- HL7: Health Level 7
 - Organisation involveret i standarder om sundhedsinformatik
- CDA: Clinical Document Architecture
 - XML standard for kliniske dokumenter
 - 1. udgave september 2000, 2. udgave juni 2005
 - HL7 Reference Information Model (RIM) & HL7 Data Types
 - Udtryksfuld og fleksibel



HL7 Data Types

Group	Code	Type
Base	ANY	Any type
Boolean	BL	Boolean
	BN	BooleanNonNull
Codes	CD	Concept Descriptor
	CE	Coded with Equivalents
	CO	Coded Ordinal
	CS	Coded Simple
	CV	Coded value
	SC	Character String with Code
Collections	BAG	Bag
	IVL	Intervals
	LIST	List
	SET	Set
Communications	URL	Uniform Resource Locator
	TEL	Telecommunications Address
Date/time	EIVL	Event-Related Periodic Interval
	GTS	Generic Time Specification
	PIVL	Periodic Interval of Time
	TS	Time Stamp

Group	Code	Type
Demographic	AD	Address
	ADXP	Address Part
	EN	Entity Name
	ENXP	Entity Name Part
	ON	Organization Name
	PN	Person Name
Identifiers	TN	Trivial Name
	II	Instance Identifier
	OID	ISO Object Identifier
	UID	Unique Identifier
Quantities	UUID	Universal Identifier
	INT	Integer
	MO	Money
	PQ	Physical Quantity
	PQR	Physical Quantity Representation
	QTY	Quantity
	REAL	Real
Text & Multimedia	BIN	Binary
	ED	Encapsulated Data
	ST	String



CDA egenskaber

- **Persistence:** continues to exist in an unaltered state, for a time period defined by local and regulatory requirements
- **Stewardship:** maintained by an organization entrusted with its care
- **Potential for authentication:** an assemblage of information that is intended to be legally authenticated
- **Context:** establishes the default context for its contents
- **Wholeness:** authentication applies to the whole and does not apply to portions of the document without the full context of the document
- **Human readability:** both human and machine readable



CDA niveauer

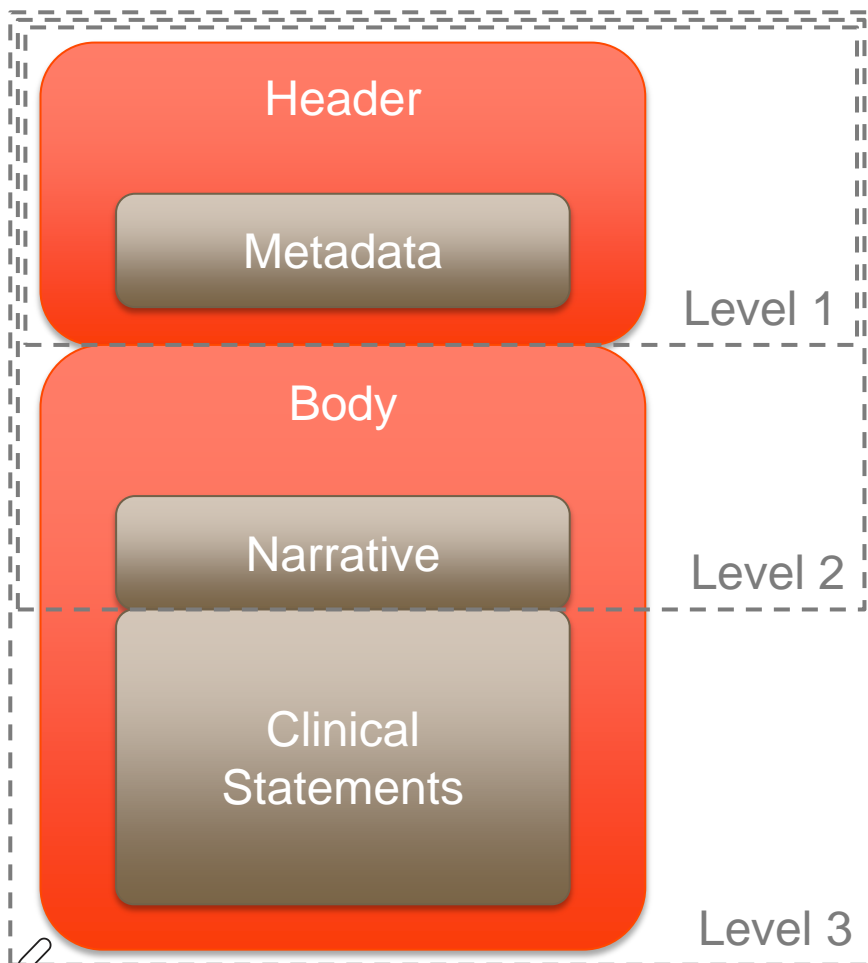

- Header is always XML
- Level 1: body is not XML
- Level 2: body is XML and sections are coded
- Level 3: body is XML and entries are coded

Identifikation

- Hovedsageligt OID
- Hierarkisk opbygget
 - HL7:
2.16.840.1.113883
 - Medcom:
2.16.840.1.113883.3.4208
- Alle kan udtrække et id og definere nyt træ
- Profilering





OID REGISTRY

HL7 Object Identifier (OID) Registry

Submitter Information

* First Name:	Michael	* Last Name:	Due Madsen
* Email:	*****	2nd Submitter:	

Contact Information

Contact for information about this Entry

* Name:	Michael Due Madsen	Address:	Forskerparken 10 DK-5230 Odense M Denmark
* Phone:	+45 23465356		
* Email:	mdm@medcom.dk		
Title/Role:	Consultant		

Responsible Body

Body Responsible for Object Being Identified with an OID

* Name:	MedCom	* Address:	Forskerparken 10 DK-5230 Odense M Denmark
* Phone:	+45 65432030		
* Email:	medcom@medcom.dk		
URL:	http://www.medcom.dk	* Type:	Standards Development Org.
Responsible Body OID:			

Internal or External OID

Internal OID

OID Information

Composite OID / GUID:	2.16.840.1.113883.3.4208
Replace By OID:	
OID Status:	OID review is complete
OID Type:	3 - Root to be a Registration Authority
V2.x Linkage:	
Assigning/Registration Authority:	HL7 International
* Full Name for Object (Title):	Root OID for OIDs used in the Danish Healthcare sector
Entry Timestamp:	2014-04-13 12:07:10.0

External OID SubType:	
Preferred_Realm:	(UV) Universal
* Desired Symbolic Name (short):	medcom

Eksempel

```
<observation classCode="OBS" moodCode="EVN">
  <templateId root="2.16.840.1.113883.10.20.1.31"/>
  <templateId root="2.16.840.1.113883.10.20.9.8"/>
  <code code="NPU03804" displayName="Legeme masse; Pt"
    codeSystem="2.16.840.1.113883.3.4208.100.1"
    codeSystemName="NPU terminologien"/>
  <value unit="kg" value="77.0" xsi:type="PQ"/>
  <methodCode code="POT" displayName="Målt af borger"
    codeSystem="2.16.840.1.113883.3.4208.100.6"
    codeSystemName="MedCom Message Codes"/>
  <methodCode code="AUT" displayName="Måling overført automatisk"
    codeSystem="2.16.840.1.113883.3.4208.100.6"
    codeSystemName="MedCom Message Codes"/>
</observation>
```

HL7 PHMR

- PHMR: Personal Healthcare Monitoring Report
- En CDA skabelon, dvs. en specialisering af CDA
- Profileret til anvendelse i Danmark
 - Medcom drev processen
 - NSI ratificerer
- Softwareunderstøttelse

IHE PCD-01

- PCD: Patient Care Devices Technical Framework
- Definerer hvordan malinger sendes fra det lokale opsamlingspunkt til det central opsamlingspunkt
- Baseret på HL7 Messaging ORU^R01 plus en enkelt SOAP-metode

```
MSH|^~\&|AcmeInc^ACDE48234567ABCD^EUI-64|||20090713090030+0000||ORU^R01^ORU_R01|MSGID1234
|P|2.6|||NE|AL|||IHE PCD ORU-R01 2006^HL7^2.16.840.1.113883.9.n.m^HL7
PID|||789567^^^Imaginary Hospital^PI ||Doe^John^Joseph^^^L^A||M
OBR|1|AB12345^AcmeAHDInc^ACDE48234567ABCD^EUI-64|CD12345^AcmeAHDInc^ACDE48234567ABCD^EUI-64
|182777000^monitoring of patient^SNOMED-CT|||20090813095715+0000
OBX|1|CWE|68220^MDC_TIME_SYNC_PROTOCOL^MDC|0.0.0.1|532224^MDC_TIME_SYNC_NONE^MDC|||R
OBX|2||528391^MDC_DEV_SPEC_PROFILE_BP^MDC|1|||||X|||||0123456789ABCDEF^EUI-64
OBX|3||150020^MDC_PRESS_BLD_NONINV^MDC|1.0.1|||||X|||20090813095715+0000
OBX|4|NM|150021^MDC_PRESS_BLD_NONINV_SYS^MDC|1.0.1.1|120|266016^MDC_DIM_MMHG^MDC|||R
OBX|5|NM|150022^MDC_PRESS_BLD_NONINV_DIA^MDC|1.0.1.2|80|266016^MDC_DIM_MMHG^MDC|||R
OBX|6|NM|150023^MDC_PRESS_BLD_NONINV_MEAN^MDC|1.0.1.3|100|266016^MDC_DIM_MMHG^MDC|||R
OBX|7|DTM|67975^MDC_ATTR_TIME_ABS^MDC|1.0.0.1|20091028123702|||||R|||20091028173702+0000
```



IEEE 11073 – Personal Health Data

IEEE Personal Health Device Standards

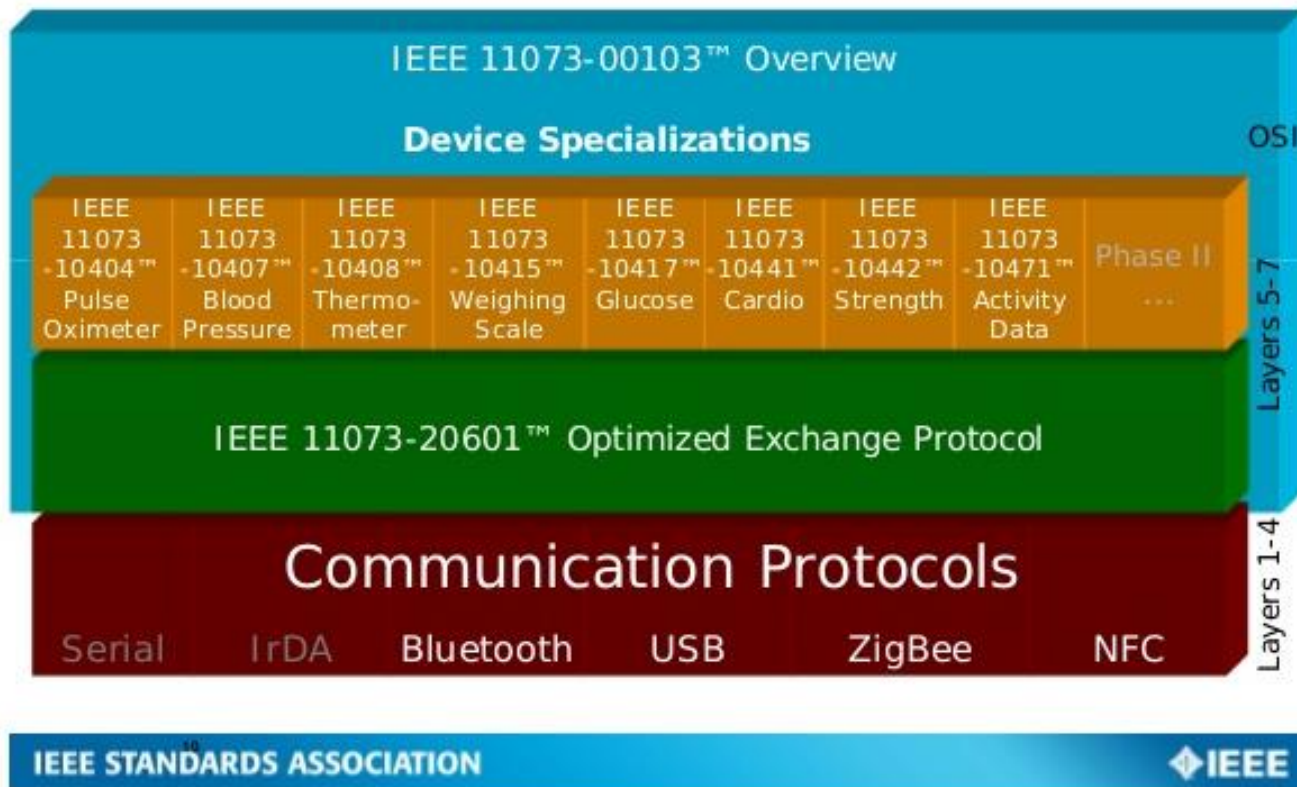

HL7 QFDD/QRD

- CDA skabelon til håndtering af spørgeskemaer
 - QFDD: Questionnaire Form Definition Document
 - QRD: Questionnaire Response Document
- Standarder endnu ikke omtalt i referencearkitekturer
- Dansk profilering i gang

GreenCDA

- CDA is hard!
- GreenCDA repræsenterer det dynamiske indhold, der kan transformeres til og fra en fuldstændig CDA

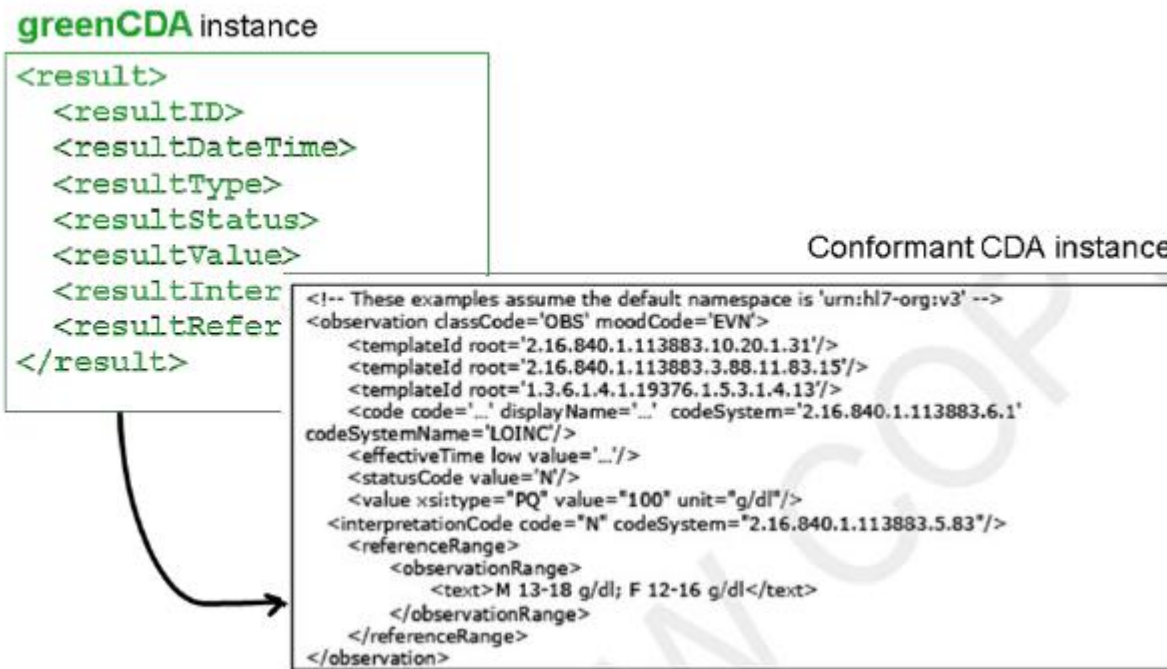

HL7 FHIR

- Fast Healthcare Interoperability Resources
 - Note: both interoperability and resources
- HL7 CDA & Messaging too hard
- Support 80%, extend for the last 20%
- Consise definition, read many times
- XML & JSON formats
- REST based identities
- Work in progress

Net4Care

- Formål: udvikle en platform, hvor SMV'er hurtigt kan eksperimentere med telemedicinsk udstyr
- Deltagelse af AU, KU og AI.
- Projektet løb 2010 – 2012.
 - Før udgivelsen referencearkitekturen for opsamling af helbredsdata hos borgeren.
- Anvender PHMR og XDS.
- Meget udførlige vejledninger og eksempler.
- Kom i gang på 4 timer!
- Se <http://net4care.dk>

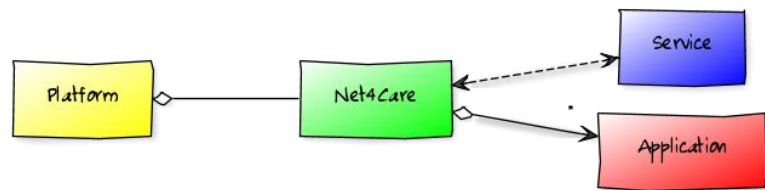



- Resultatkontrakten: Danmark som telemedicinsk foregangsland.
- Deltagelse af: Alexandra Instituttet, Delta, Teknologisk Institut og Force Technology.
- Løber i 2013 – 2015.
- Financierer bl.a. stiftelsen af 4S.
- Udviklingsplatformen udgør ca. 10% af projektet

Økosystem
Efterspørgsel
Leverandører
Udviklingsplatform
Demo-projekter
Organisering og
Ledelse

Udviklingsplatformen – V1

- Videreudvikling på Net4Care-platformen
- Vidensdeling
 - Samtaler med virksomheder
 - Videnskabelige artikler
- 200+ unikke downloads i 25+ lande primo 2014
- Anvendt til live-demo på UNIK-konference
 - 3 produkter leverer data ind i platformen
 - 2 andre produkter henter data i XDS
 - Heraf 1 i EPJ med samtykke gennem NSP



Infrastrukturværktøjerne – V2

- Modularisering
- Nye OpenTele tiltag bliver generelt anvendelige moduler
- Udvikling af procesapparatet
 - Jira, Bitbucket, Wiki, websted, ...
- Samarbejde på tværs af firmaer

PHMR Builder

- Udviklet i parallel med PHMR-profileringen
 - Vigtig ift. korrektheden af profilen
- Udviklet i et samarbejde mellem
 - Aarhus Universitet, Alexandra Instituttet og Silverbullet
- Anvendes for nuværende i
 - KIH databasen, Silverbullet
 - Next Step Citizen
 - Undersøges ift. AK-behandlingen, Systematic



OpenTele

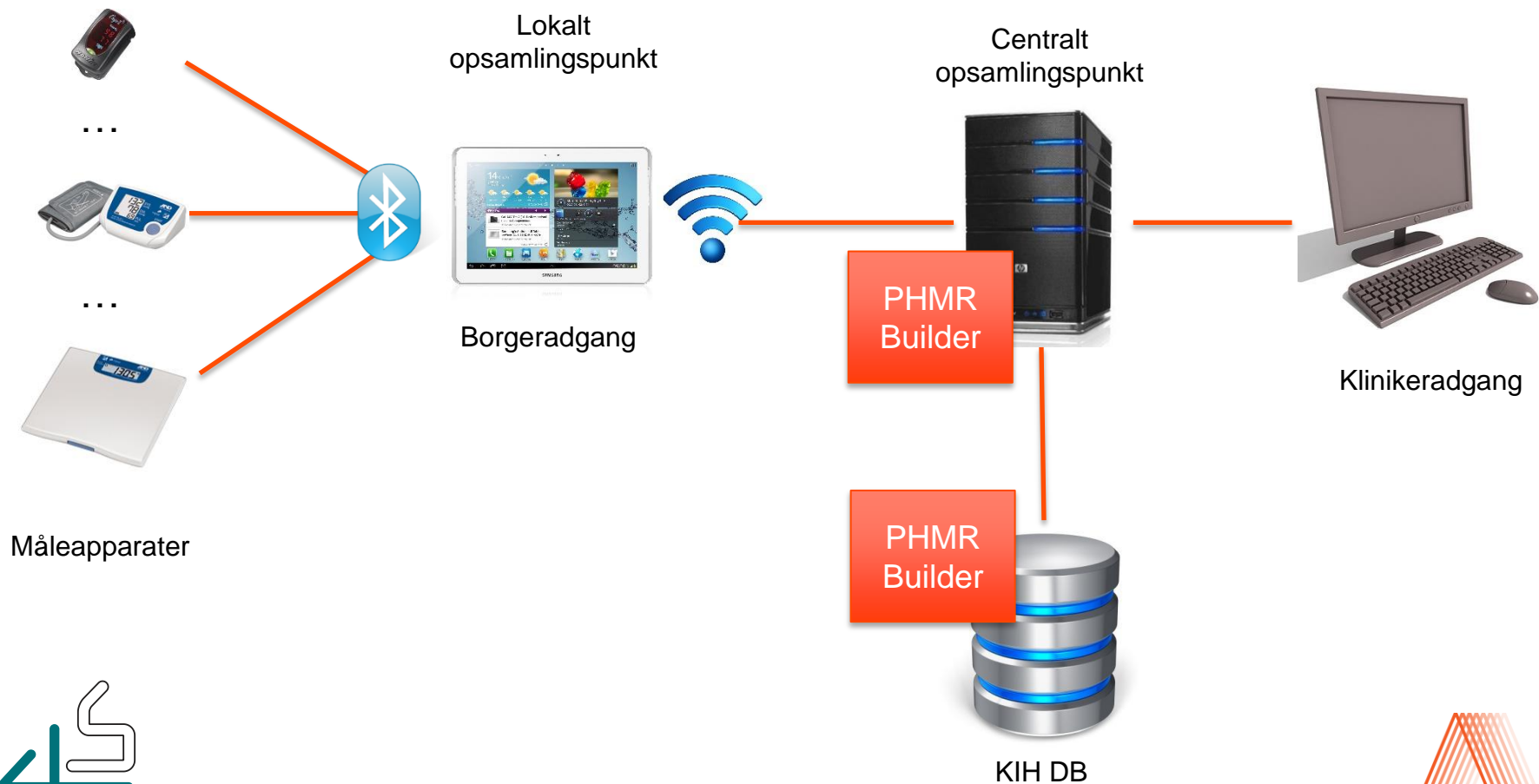

PHMR Builder

- Bygger på GreenCDA-princippet
 - Dvs tilføj dynamisk information, builderen tilføjer det statiske
 - Objektmodel til håndtering af dynamisk information
 - "Builders" til at bygge det dokument, som ønskes
- Udvidelser: QFDD, QRD, XDS metadata, PCD-01, ...

```
PersonIdentity kaj =
    new PersonIdentity.PersonBuilder("Hansen").
        addGivenName("Kaj").
        setGender(Gender.Male).
        setPersonID("1711001357").
        setAddress(address).
        addTelecom(AddressData.Use.HomeAddress, "tel", "98123456").
        setBirthTime(2000, Calendar.NOVEMBER, 17).build();
cda.setPatient(kaj)
...
DanishPHMRBuilder phmrBuilder = new DanishPHMRBuilder();
cda.construct(phmrBuilder);
Document xmlDoc = phmrBuilder.getDocument();
```

IUA Service



- *Internet User Authorization*
 - Fra 2013, status er *trial implementation*
- Optimeret til
 - Mobiladgang, REST
 - Multiple autorisationsudbydere
- Understøtter JWT, SAML, OAuth
- Mockup af *get authorization token* med JWT
 - 2-faktor OpenTele borgerlogin

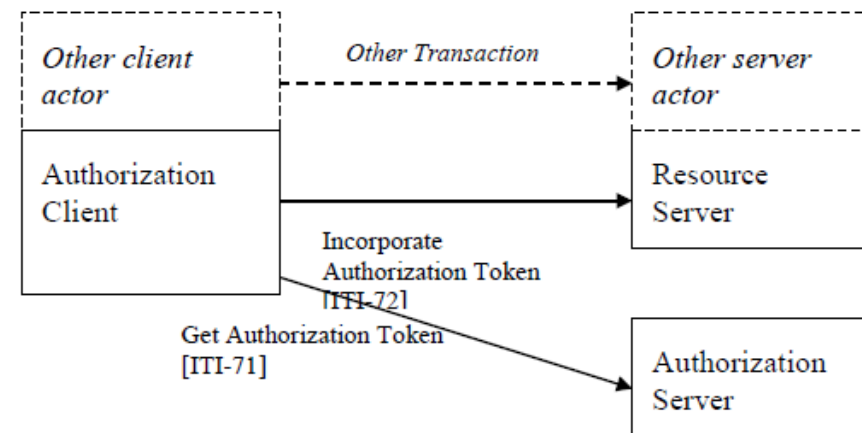

MHD Service



- *Mobile access to Health Documents*
 - Fra 2012, status er *trial implementation*
- **Simpel REST-adgang til XDS**
 - Simplificeret til anvendelse i en enkelt domæne
 - Fx: `http://<location>/<patientID>/Document/<entryUUID>/`
- **Mockup af *get & find***
 - Adapter foran XDS
 - Testet på
 - MS-XDS
 - EMC-XDS
 - KIH-DB (repository)

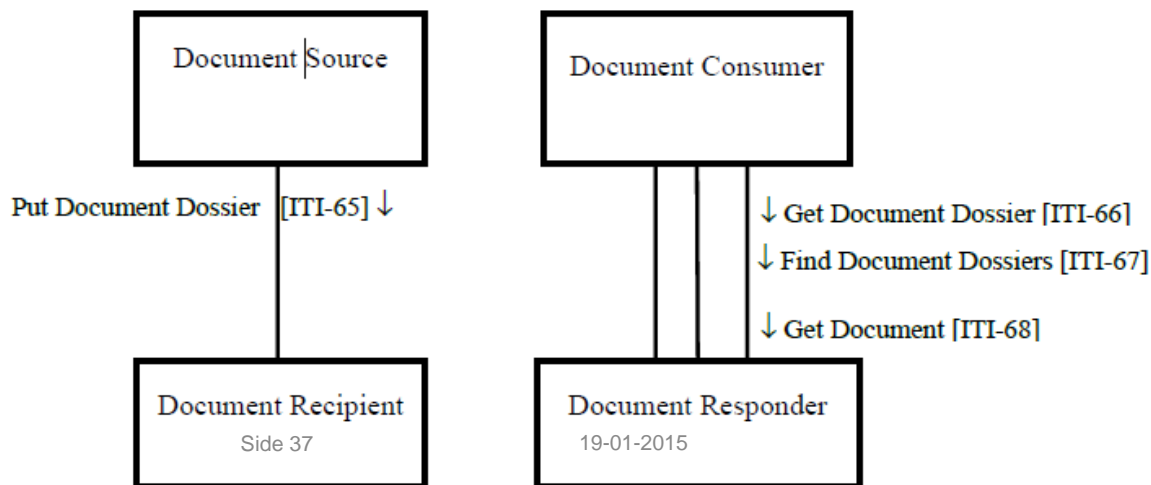

PHMR Viewer

- Mockup af simpel visning af dokument
- Simpel søgning på CPR og tidsinterval
- Henter dokumenter med MHD
- Rendering i HTML vha. cda.xsl fra HL7



The screenshot shows a web application interface for 'PHMR Viewer'. At the top, there is a header with the text 'Stiftelsen for softwarebaserede sundhedsservices' and a search bar containing 'Søg PHMR'. Below the header is a large image of a person's hands writing in a notebook, with the text 'PHMR Viewer' overlaid in white. Underneath the image, the title of the document is 'Next Step Citizen teleobservation for patient 2512484916'. The main content area displays patient and document information in a structured format.

Next Step Citizen teleobservation for patient 2512484916			
Patient:			
Date of Birth:	December 25, 1948	Sex:	Female
Contact Info:	address not available Telecom information not available	Patient IDs:	2512484916 2.16.840.1.113883.3.3115.2.1
Document Id:	23b75313-1224-4af6-872a-bf43484a83d2 2.16.840.1.113883.3.3115		
Document Created:	May 5, 2014, 13:08:00		

4SDC

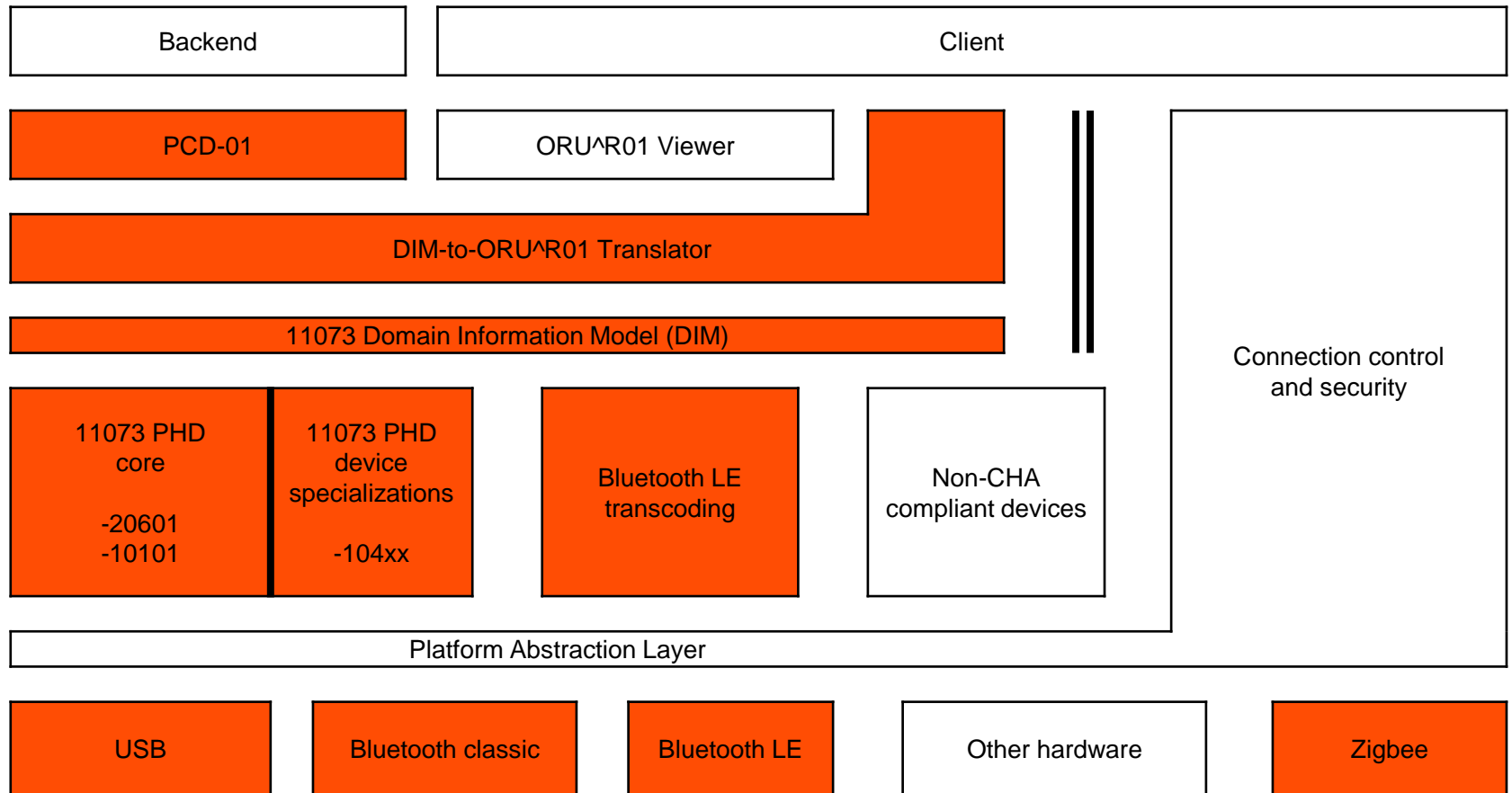

Overblik

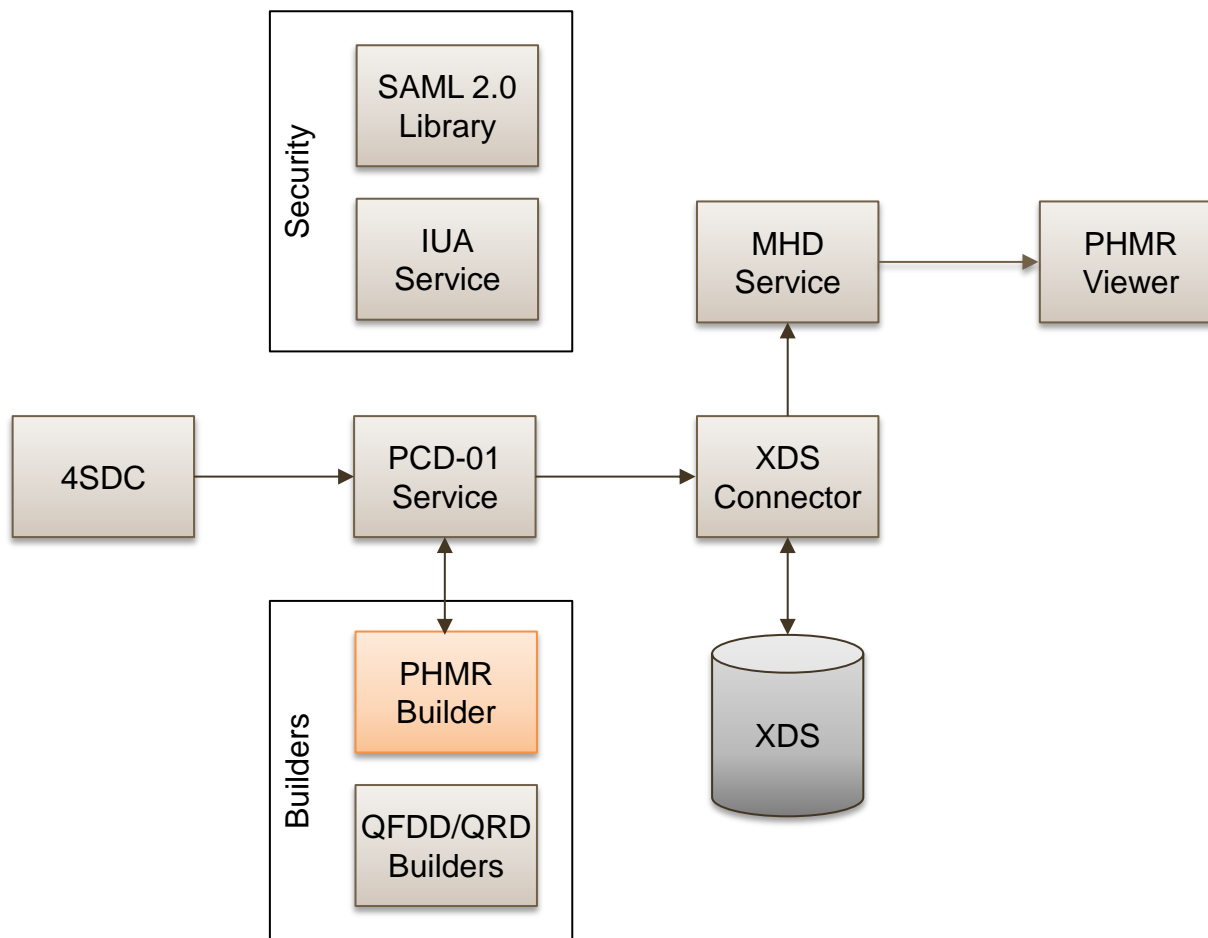

Muligheder med XDS/PHMR

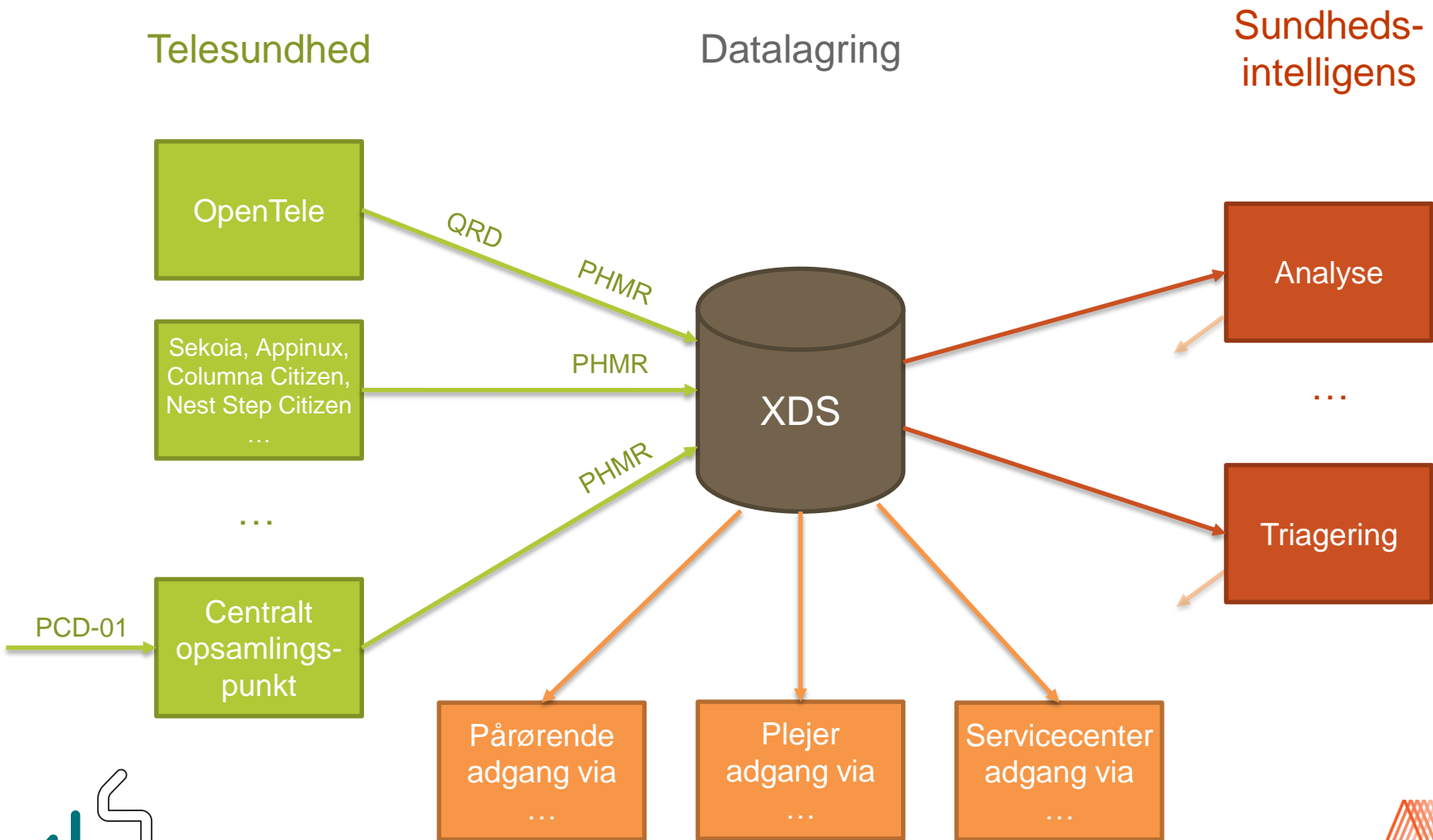

InnoBooster

- Mulighed for tilskud op til 250.000 kr til
- Virksomheder med mellem 2 og 250 ansatte
- Se <http://www.alexandra.dk/dk/aktuelt/nyheder/nyheder-2014/jul-sep/sider/innovationsparate-virksomheder-soeges.aspx>

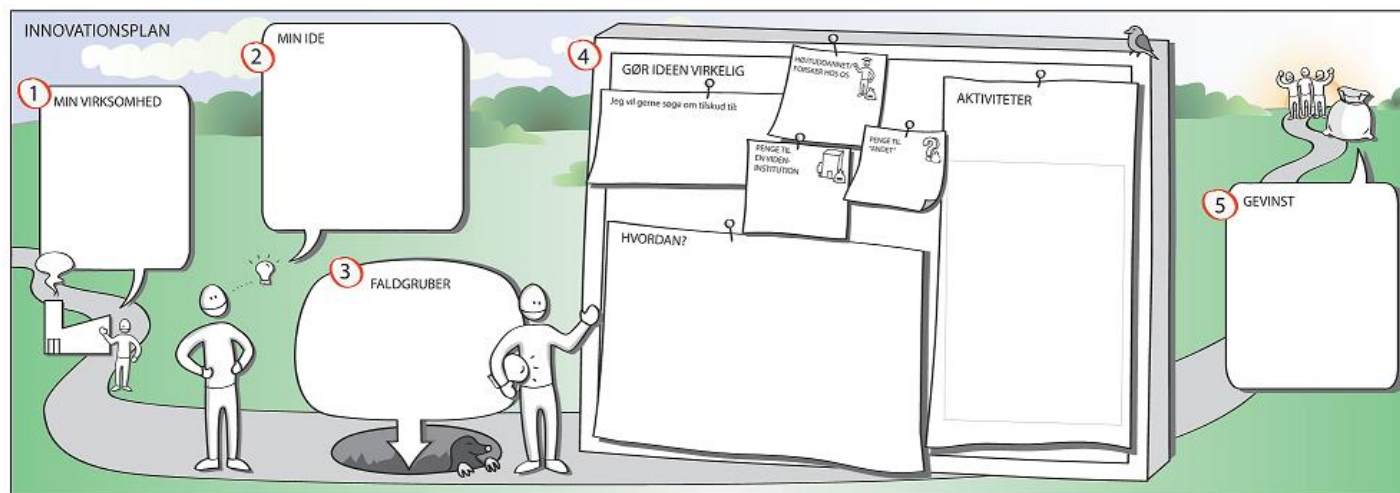

Spørgsmål



Standarder & anbefalinger

- NSI: [http://www.ssi.dk/Sundhedsdataogit/National Sundheds-it/Standardisering/Referencearkitektur.aspx](http://www.ssi.dk/Sundhedsdataogit/National_Sundheds-it/Standardisering/Referencearkitektur.aspx)
- Continua: <http://www.continuaalliance.org/products/design-guidelines>
- IHE: [http://wiki.ihe.net/index.php?title=Profiles#IHE IT Infrastructure Profiles](http://wiki.ihe.net/index.php?title=Profiles#IHE_IT_Infrastructure_Profiles)
- HL7: http://www.hl7.org/implement/standards/product_matrix.cfm
 - Bog: <http://www.springer.com/public+health/book/978-0-85729-335-0>

Softwareressourcer

- 4S
 - Wiki: <http://4s-online.dk/wiki>
 - Bitbucket: <https://bitbucket.org/4s>
 - JIRA: <https://issuetracker4s.atlassian.net>
- NSP: National Service Platform
 - Web: <https://www.nspop.dk/display/web>
 - Minlog
 - Dokumentdelingservice
 - Samtykke
 - ...

